







PLC12 SERIES DIMENSIONS

COUPLING BODIES - Polypropylene

TERMINATION	TUBING/THREAD SIZE	METRIC EQ	STRAIGHT THRU	SHUTOFF	A	B
 IN-LINE PIPE THREAD	1/4" NPT		PLC1000412	PLCD1000412	1 (25.4)	1.15 (29.2)
	1/4" BSPT		PLC1000412BSPT	PLCD1000412BSPT	1 (25.4)	1.15 (29.2)
	3/8" NPT		PLC1000612	PLCD1000612	1 (25.4)	1.15 (29.2)
	3/8" BSPT		PLC1000612BSPT	PLCD1000612BSPT	1 (25.4)	1.15 (29.2)
 PANEL MOUNT FERRULELESS POLYTUBE FITTING, PTF†	3/8" OD, 1/4" ID	9.5mm OD, 6.4mm ID	PLC1200612	PLCD1200612	1 (25.4)	1.95 (49.5)
 PANEL MOUNT HOSE BARB	1/4" ID	6.4mm ID	PLC1600412	PLCD1600412	1 (25.4)	1.95 (49.5)
	3/8" ID	9.5mm ID	PLC1600612	PLCD1600612	1 (25.4)	1.95 (49.5)
 IN-LINE FERRULELESS POLYTUBE FITTING, PTF†	3/8" OD, 1/4" ID	9.5mm OD, 6.4mm ID	PLC1300612	PLCD1300612	1.02 (25.9)	1.96 (49.8)
 IN-LINE HOSE BARB	1/4" ID	6.4mm ID	PLC1700412	PLCD1700412	1.02 (25.9)	1.96 (49.8)
	3/8" ID	9.5mm ID	PLC1700612	PLCD1700612	1.02 (25.9)	1.96 (49.8)

COUPLING READERS - Polypropylene

TERMINATION	TUBING/THREAD SIZE	METRIC EQ	STRAIGHT THRU	SHUTOFF	A	B
 IN-LINE HOSE BARB (RS-232 INTERFACE)	1/4" ID	6.4mm ID		iPLCDR1700400	1.39 (35.3)	2.78 (70.6)
	3/8" ID	9.5mm ID		iPLCDR1700600	1.39 (35.3)	2.78 (70.6)
IN-LINE HOSE BARB (USB INTERFACE)	3/8" ID	9.5mm ID		iPLCDR1700601	1.05 (26.7)	1.74/1.87 (44.2/47.5)

All measurements are in inches (millimeters) unless otherwise noted. Tubing must meet stated inside and outside diameters. †NOTE: CPC's Ferruleless Polytube Fitting terminations do not require ferrules to achieve a secure connection, which makes them easier to use and reuse. PTF fittings are designed for semi-rigid tubing, i.e., polyethylene, nylon, polyurethane, etc. NOTE: JG is a registered trademark of John Guest USA, Inc.

PRODUCT DIMENSIONS

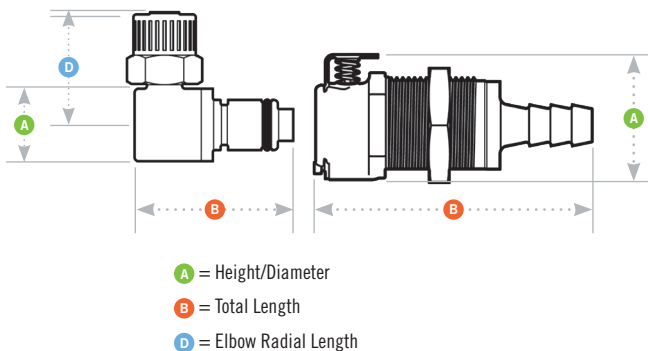

PANEL DIMENSIONS

	PANEL OPENING	PANEL THICKNESS MAX.-MIN.	PANEL NUT HEX	PANEL NUT THREAD
COUPLING BODIES	see drawing	0.30 – 0.02	13/16	11/16-24UNEF
COUPLING INSERTS	see drawing	0.30 – 0.02	13/16	11/16-24UNEF

