

**SERIES 3  
 ROTARY VANE PUMP  
 CLAMP-ON STYLE  
 "B" MOUNTING  
 3/8" NPT PORTS  
 WITH RELIEF VALVE**

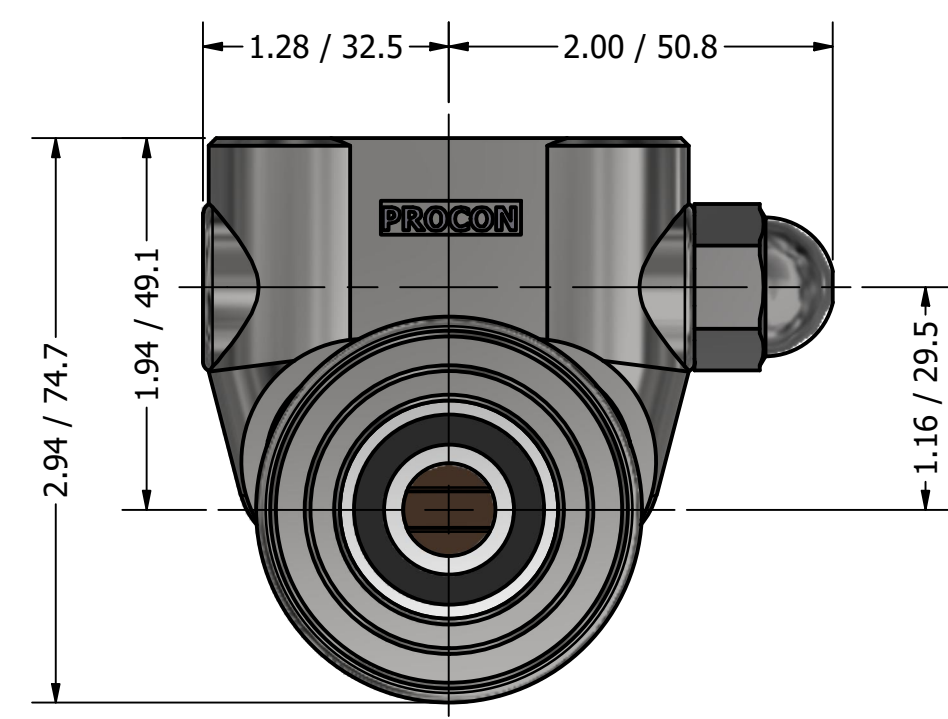
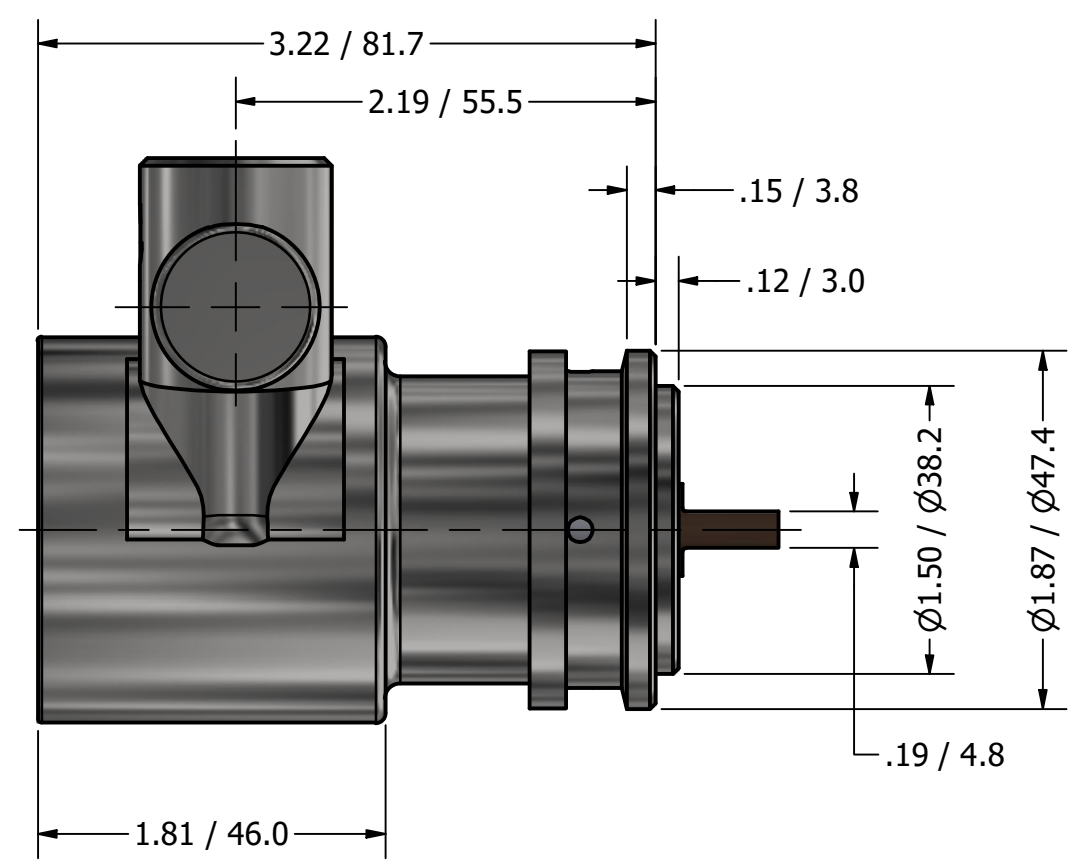
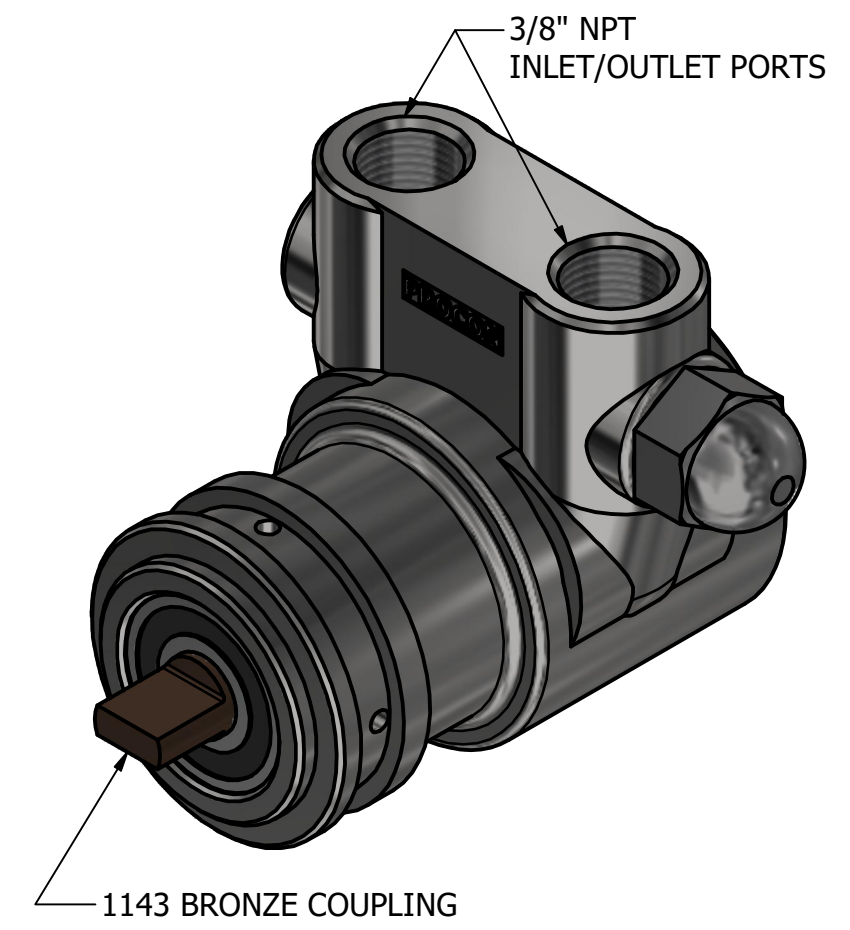
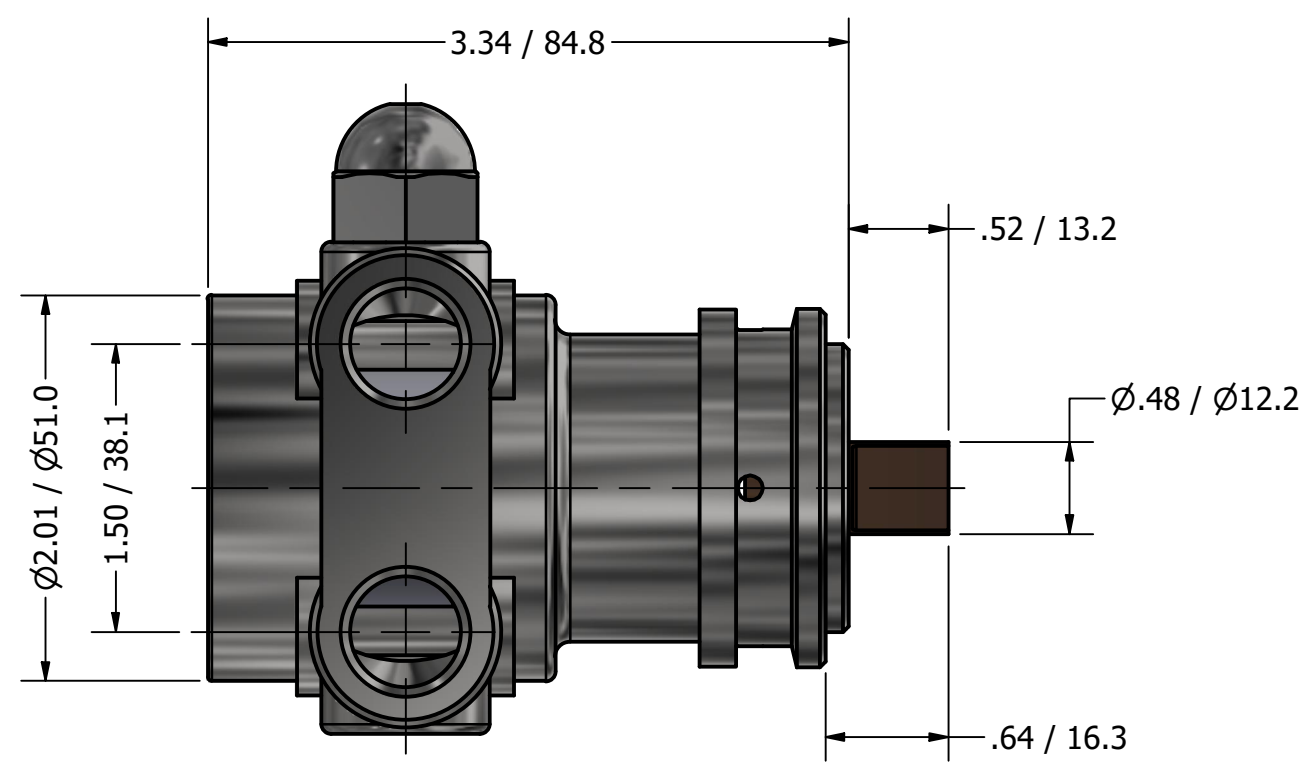

## Series 1, 2, and 3 Nominal Volume\*

Flow rate (GPH/ LPH)	Gallons Per Hour/Liters Per Hour					Brake Horsepower/Watts (motor shaft power)				
	Pressure (PSI/Bar)					Pressure (PSI/Bar)				
	50/3.4	100/6.9	150/10.3	200/13.8	250/17.5	50/3.4	100/6.9	150/10.3	200/13.8	250/17.5
140/425	143/447	141/441	139/434	137/428	135/422	0.17/127	0.28/209	0.40/298	0.52/387	0.63/469
125/375	128/400	126/394	124/388	122/381	120/375	0.16/119	0.26/194	0.36/268	0.47/350	0.57/425
110/330	111/347	109/341	107/334	105/328	103/322	0.15/112	0.25/186	0.34/253	0.44/328	0.54/402
100/300	102/319	100/313	98/306	96/300	94/294	0.13/97	0.20/149	0.28/209	0.35/261	0.42/313
80/240	82/257	80/256	78/244	76/238	74/231	0.12/89	0.18/134	0.25/186	0.32/238	0.39/291
70/210	72/225	70/219	68/213	66/206	64/200	0.11/82	0.17/127	0.24/179	0.30/224	0.37/276
60/180	62/194	60/188	58/181	56/175	54/169	0.10/75	0.16/119	0.23/171	0.29/216	0.35/261
50/150	52/163	50/157	48/150	46/144	44/138	0.09/67	0.15/112	0.21/157	0.27/201	0.33/246
35/100	37/116	35/110	33/103	31/97	29/91	0.08/51	0.14/104	0.19/142	0.24/179	0.29/216
25/75	27/85	25/78	23/72	21/66	19/59	0.07/52	0.12/89	0.17/127	0.22/164	0.27/201
15/45	17/53	15/47	13/41	11/34	--	0.06/45	0.10/75	0.15/112	0.19/142	--

\*GPH rating at 1725 RPM/60Hz and LPH rating at 1450 RPM/50Hz.

Performance based on pump tested with water at room temperature For certificate of compliance or declarations please visit [www.proconpumps.com](http://www.proconpumps.com) or email [productcompliance@proconpump.com](mailto:productcompliance@proconpump.com)

**PROCON**<sup>®</sup>  
custom | fluid | solutions<sup>®</sup>

**FC1001 v2**