

**SERIES 4
ROTARY VANE PUMP
CLAMP-ON STYLE
"D" MOUNTING
1/2" NPT PORTS
WITH RELIEF VALVE**

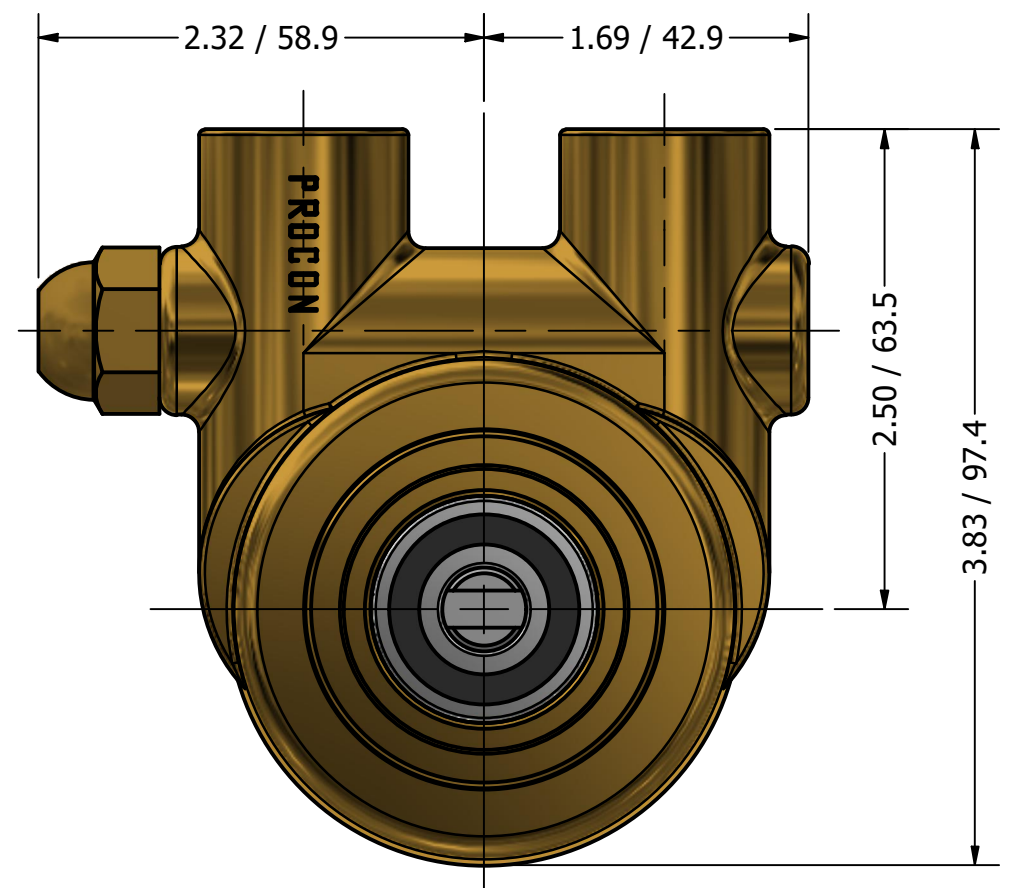

Series 4 and 5 Nominal Volume*

Flow rate (GPH/ LPH)	Gallons Per Hour/Liters Per Hour					Brake Horsepower/Watts (motor shaft power)				
	Pressure (PSI/Bar)					Pressure (PSI/Bar)				
	50/3.4	100/6.9	150/10.3	200/13.8	250/17.5	50/3.4	100/6.9	150/10.3	200/13.8	250/17.5
330/1,000	331/1,034	330/1,031	328/1,025	327/1,022	326/1,019	0.33/246	0.55/410	0.78/581	1.00/745	1.22/909
265/800	265/828	263/822	261/816	259/809	257/803	0.24/179	0.43/320	0.63/469	0.82/611	1.01/753
240/725	243/759	240/750	236/738	232/725	228/713	0.21/157	0.37/276	0.54/402	0.70/522	0.86/641
215/650	218/681	215/672	211/659	207/647	203/634	0.20/149	0.35/261	0.50/3723	0.65/484	0.80/596
190/575	193/603	190/594	189/591	182/569	178/556	0.18/134	0.33/246	0.47/351	0.61/455	0.75/559
165/500	168/525	165/516	161/503	157/491	153/478	0.17/127	0.30/224	0.43/320	0.57/425	0.70/522
140/425	143/447	140/438	136/425	132/413	128/400	0.16/119	0.28/209	0.40/298	0.52/387	0.64/477
115/350	116/363	115/359	111/347	107/334	103/322	0.15/112	0.25/186	0.35/261	0.45/335	0.55/410

*GPH rating at 1725 RPM/60Hz and LPH rating at 1450 RPM/50Hz.

Performance based on pump tested with water at room temperature For certificate of compliance or declarations please visit www.proconpumps.com or email productcompliance@proconpump.com

PROCON[®]
custom | fluid | solutions[®]

FC1002 v2