

HELICAL GEAR PUMP 30 WATT MOTOR G1/8 (BSPP) PORTS

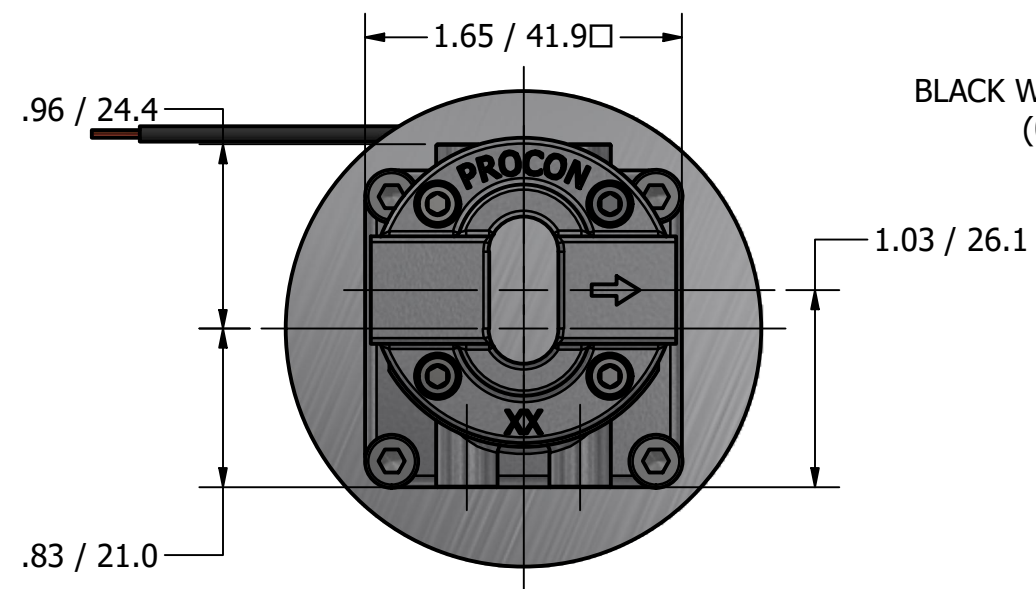

9mm HELICAL GEAR PUMP WITH 24V/30W, 35W, 50W, 70W BRUSHED MOTOR

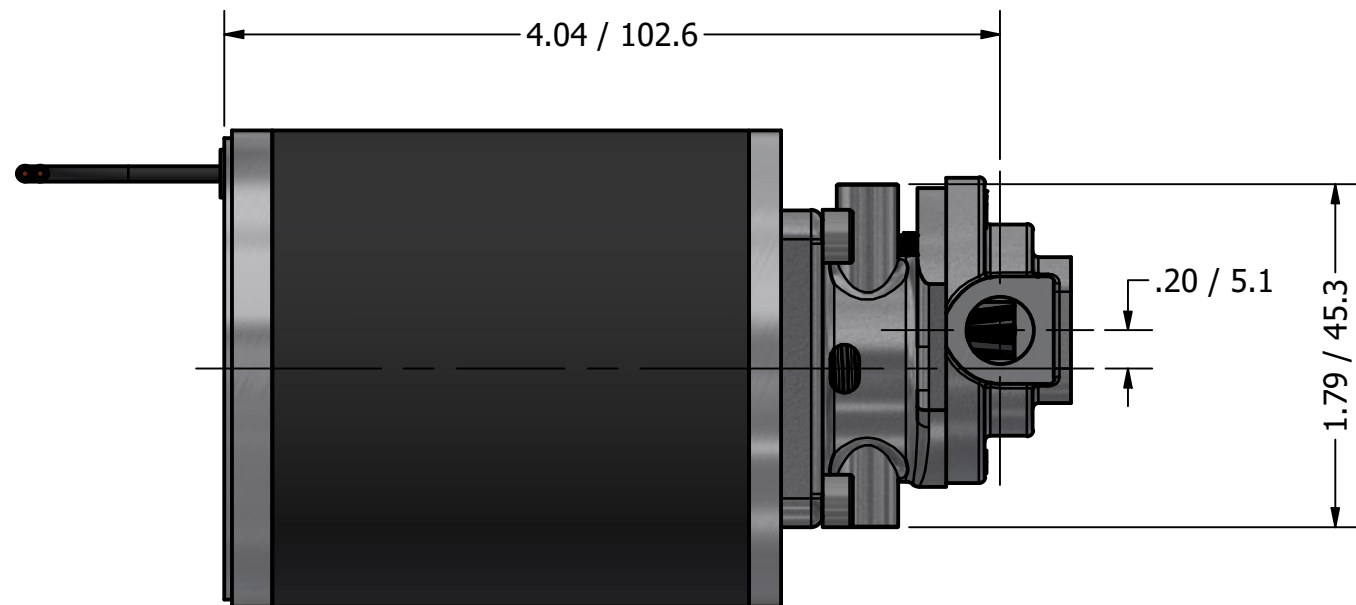
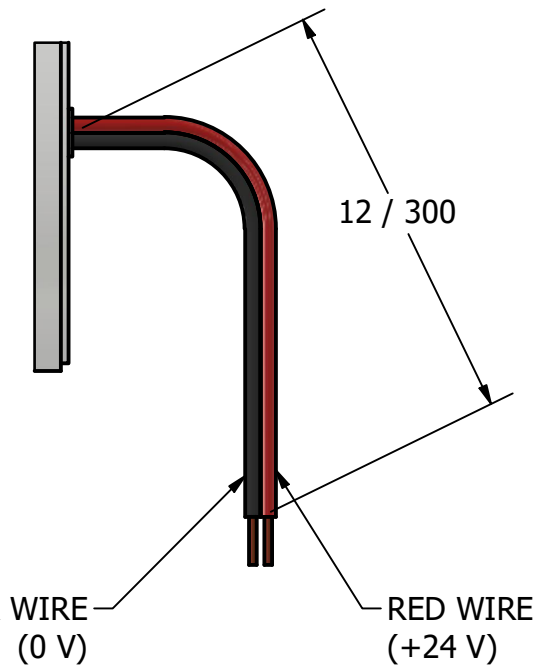