

**MICRO GEAR PUMP
20 WATT MOTOR
G1/8 (BSPP) PORTS**

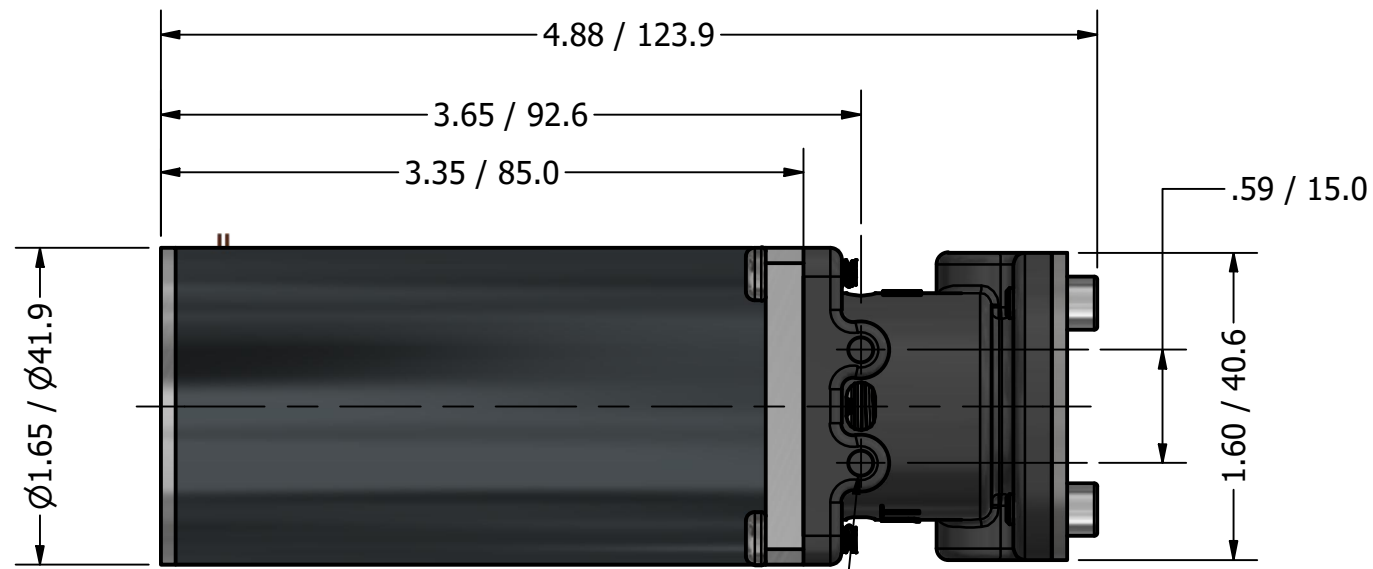

M4 X 0.7 X .236±.01 / 5.99±0.3 DEEP
4 PLCS

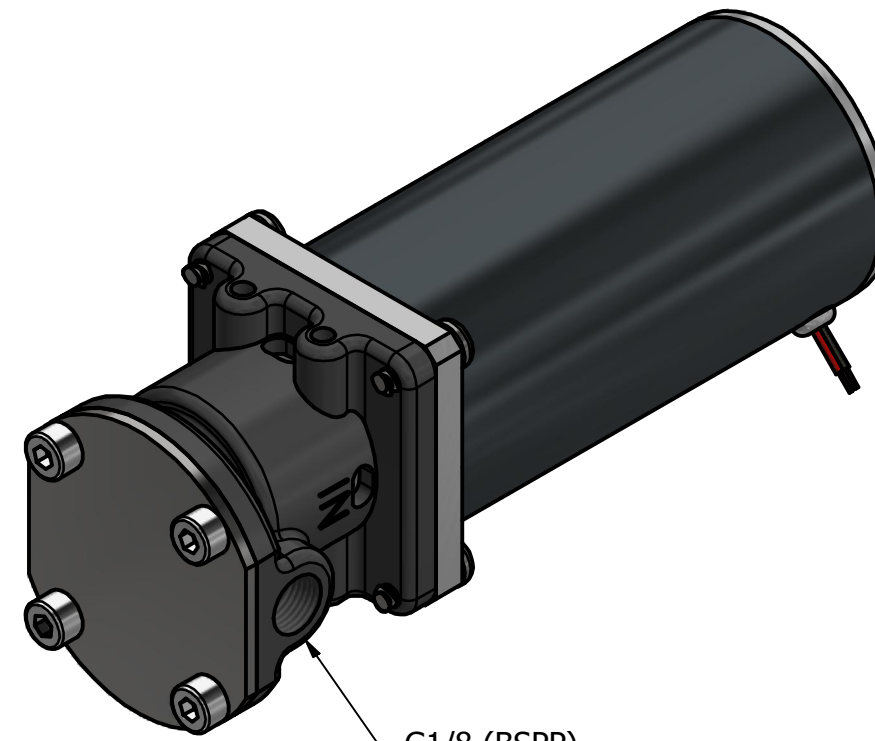

G1/8 (BSPP)
INLET/OUTLET PORTS

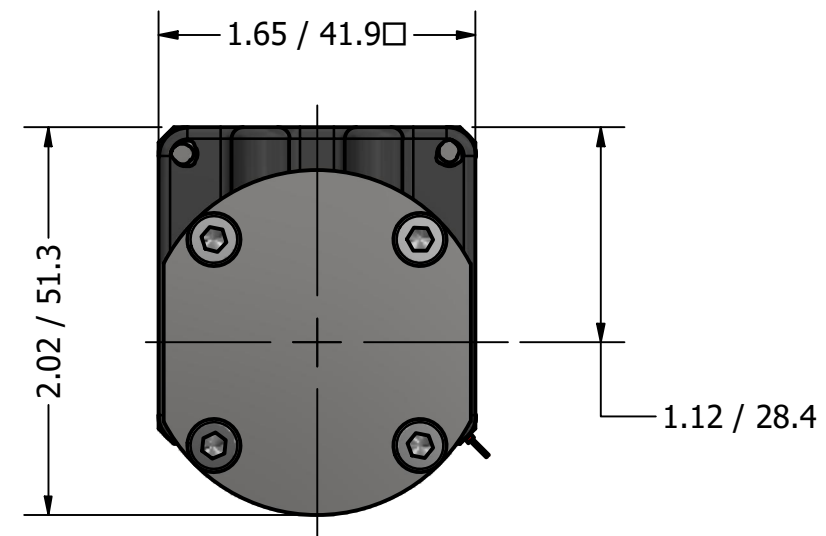
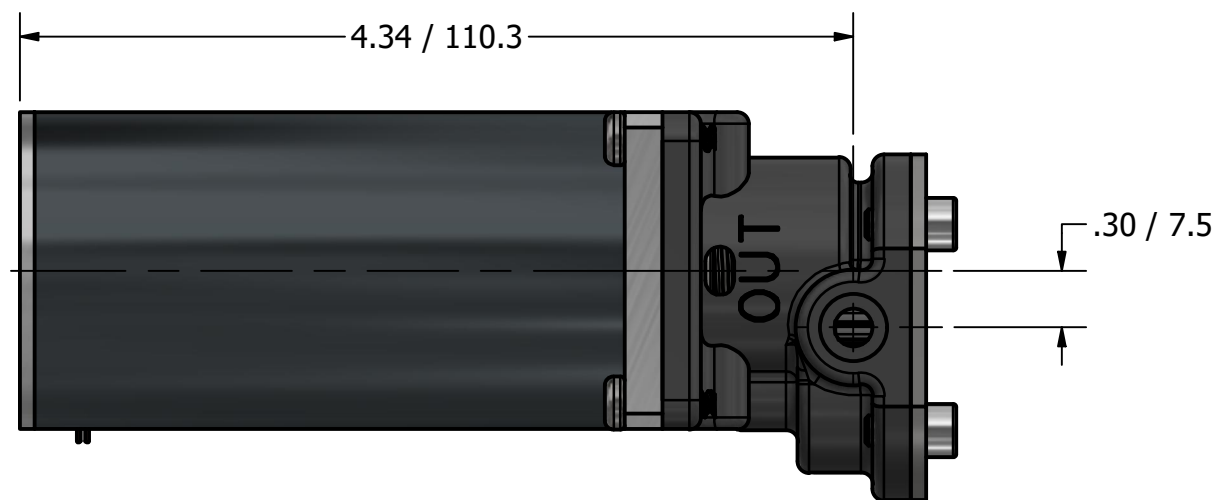
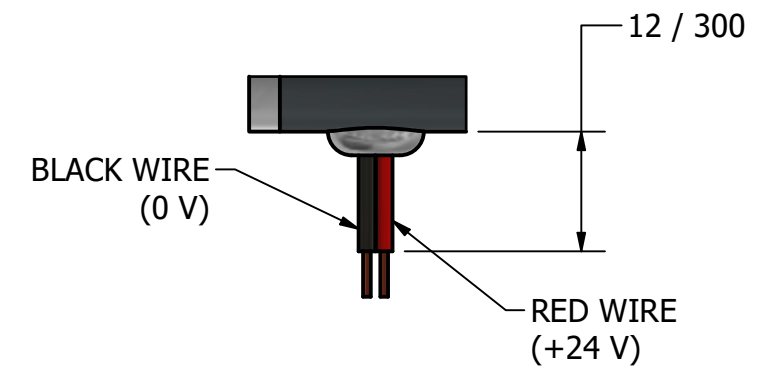

10mm SPUR GEAR PUMP WITH 24V/20W 30W 40W 60W BRUSHED DC MOTOR

