

10-STEP ROLLING STEEL WAREHOUSE LADDER - LAD-10-21-P

APPROX WEIGHT: 254.7023 lbs.
DOES NOT INCLUDE WEIGHT OF POWER OR PACKAGING!!!

*** ANY ADDITIONS, DELETIONS, OR OMISSIONS MUST BE CORRECTED ON THIS DRAWING AS THIS DRAWING WILL BE CONSIDERED ALL INCLUSIVE ***

ALL GRAPHICS PROVIDED ARE FOR REFERENCE ONLY. IF CERTAIN DIMENSIONS ARE CRITICAL PLEASE VERIFY THOSE DIMENSIONS WITH YOUR SALESPERSON

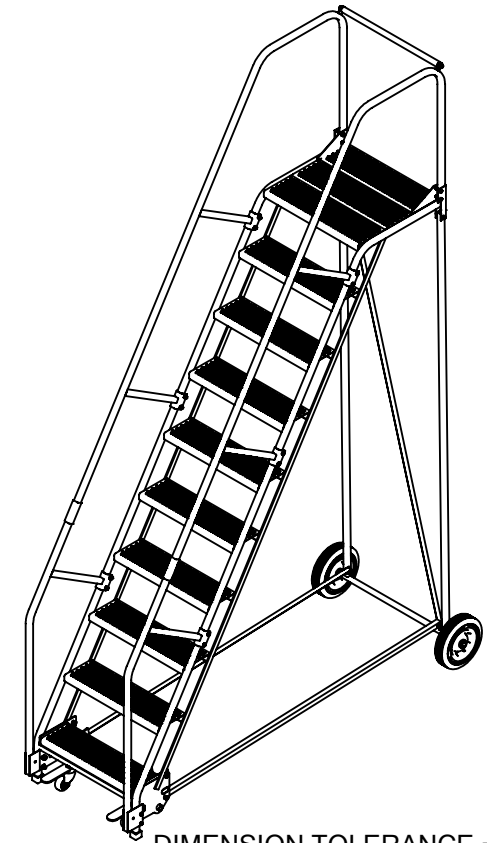
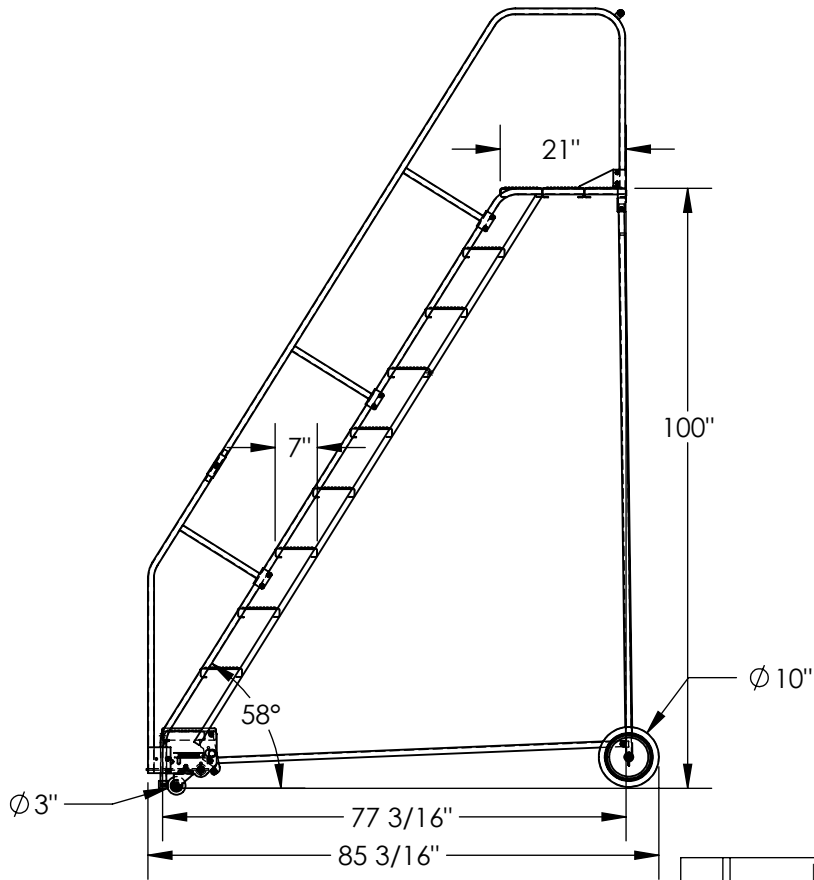
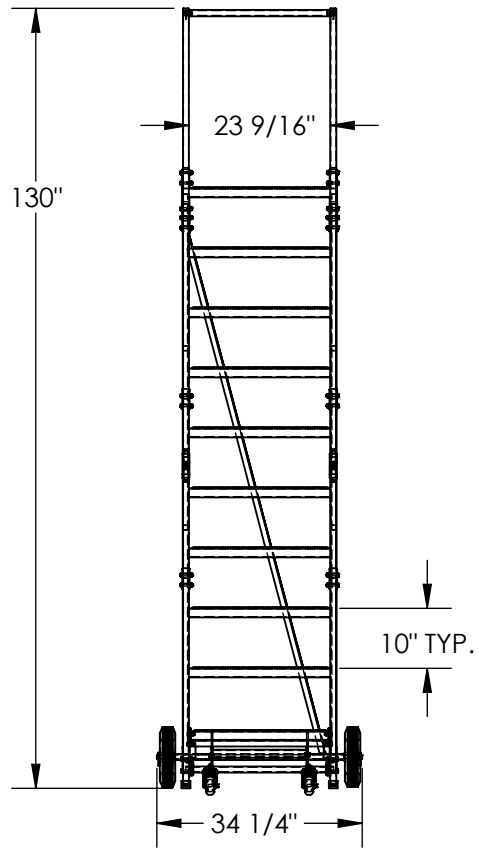

DIMENSION TOLERANCE ± 1/4"

STANDARD FEATURES

MODEL NUMBER IS LAD-10-21-P
OVERALL WIDTH IS 34 1/4"
USABLE WIDTH IS 23 9/16"
OVERALL LENGTH IS 85 3/16"
USABLE LENGTH IS 77 3/16"
OVERALL HEIGHT IS 130"
TOP STEP HEIGHT IS 100"
STEP TYPE IS PERFORATED
CLIMB ANGLE IS 58°
STEP DEPTH IS 7"
TOP STEP DEPTH IS 21"
MAX CAPACITY IS 350 LBS
WHEEL SIZE IS Ø10"
FRONT WHEEL SIZE IS Ø3"
TOUGH BAKED IN POWDER COATED BLUE FINISH
BOTTOM STEP HAS TOUGH BAKED IN
POWDER COATED YELLOW FINISH

NOTE

- SOME ASSEMBLY REQUIRED
- TOOL TRAY SOLD SEPARATELY
- SAFETY GATE SOLD SEPARATELY

SPECIAL FEATURES

NONE

APPROVAL

I, THE UNDERSIGNED, AGREE THAT THE PRODUCT AS REPRESENTED SATISFIES DESIGN AND DIMENSION REQUIREMENTS. I ALSO ACKNOWLEDGE MY DUTY TO CONFIRM PRODUCT AND INSTALLATION COMPLIANCE WITH ALL APPLICABLE FEDERAL, STATE AND LOCAL REGULATIONS AND STANDARDS.
UNITS REQUIRING APPROVAL DRAWINGS OR MODIFIED ARE NON-RETURNABLE

[] As drawn [] As marked

Signed: _____ Date: _____

Printed Name: _____

LEAD TIME WILL START UPON RECEIPT OF SIGNED APPROVAL DRAWING

DISTRIBUTOR'S NAME:		P.O.#
VESTIL MANUFACTURING		X
DRAWN BY: BCN		W.O.#
DATE: 7/14/2016		X
REFERENCE: X	SCALE: 1:32	SALES: X
QUOTED LEAD TIME: X	QUOTE #	FILE NAME:
	X	44-007-131