

STANDARD SLOPE LADDER, 7-STEP, PERFORATED - LAD-PW-32-7-P

APPROX WEIGHT: 178.03 lbs.
DOES NOT INCLUDE WEIGHT OF POWER OR PACKAGING!!!

*** ANY ADDITIONS, DELETIONS, OR OMISSIONS MUST BE CORRECTED ON THIS DRAWING AS THIS DRAWING WILL BE CONSIDERED ALL INCLUSIVE ***
ALL GRAPHICS PROVIDED ARE FOR REFERENCE ONLY. IF CERTAIN DIMENSIONS ARE CRITICAL PLEASE VERIFY THOSE DIMENSIONS WITH YOUR SALESPERSON

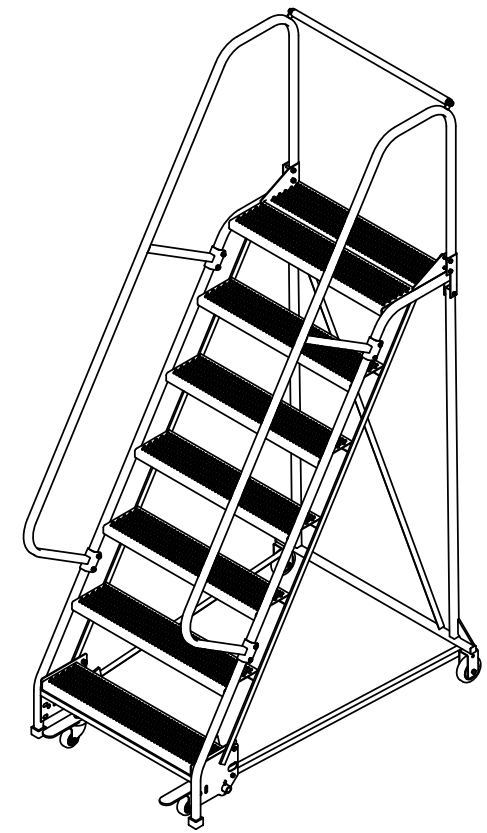
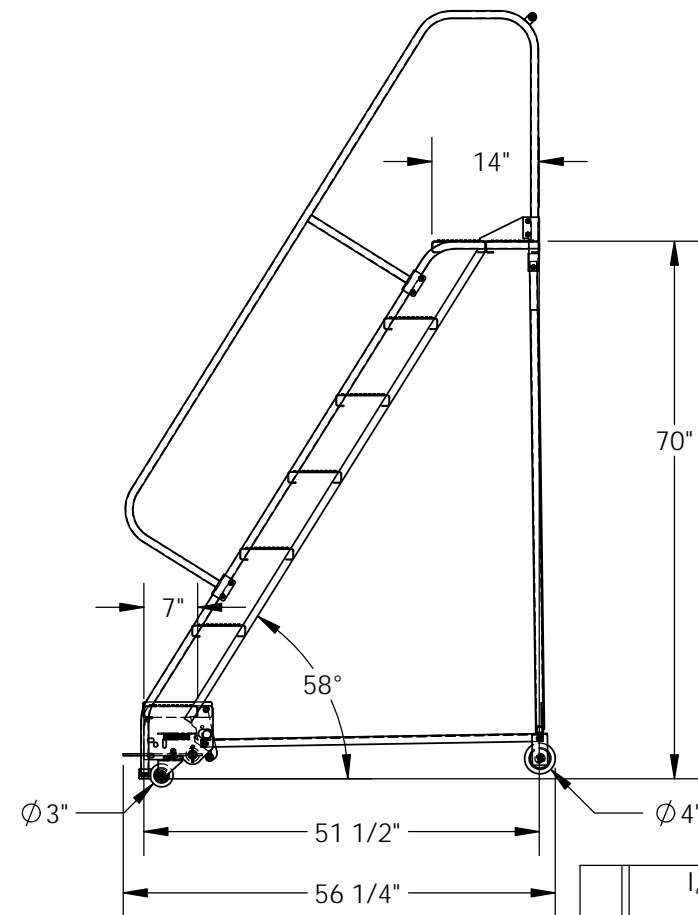
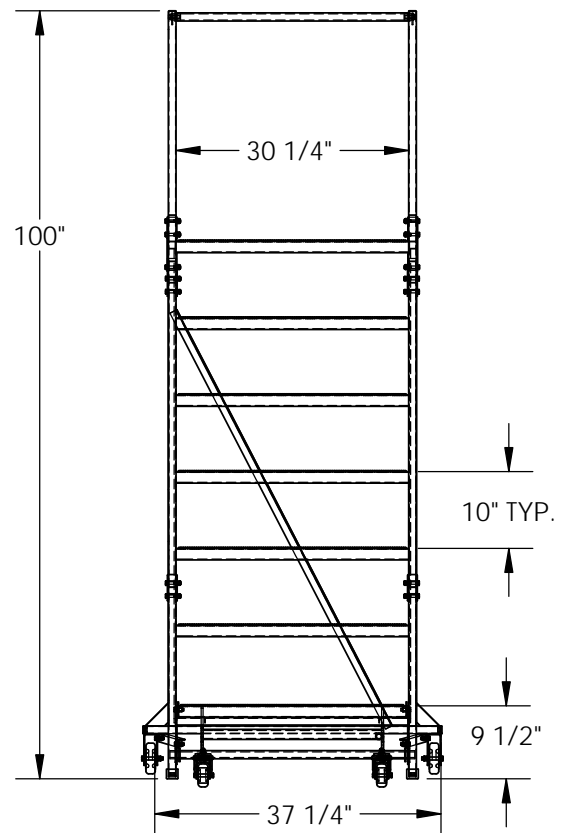

DIMENSION TOLERANCE ± 1/4"

STANDARD FEATURES

- MODEL NUMBER IS LAD-PW-32-7-P
- OVERALL WIDTH IS 37 1/4"
- USABLE WIDTH IS 30 1/4"
- OVERALL LENGTH IS 56 1/4"
- USABLE LENGTH IS 51 1/2"
- OVERALL HEIGHT IS 100"
- PLATFORM HEIGHT IS 70"
- STEP TYPE IS PERFORATED
- CLIMB ANGLE IS 58°
- STEP DEPTH IS 7"
- PLATFORM DEPTH IS 14"
- COLOR IS VESTIL BLUE
- BOTTOM STEP COLOR IS YELLOW
- MAX CAPACITY IS 350 LBS
- FRONT WHEEL IS SWIVEL, SIZE IS Ø 3"
- REAR WHEEL IS RIGID, SIZE IS Ø 4"

NOTE

SOME ASSEMBLY REQUIRED
TOOL TRAY SOLD SEPARATELY

SPECIAL FEATURES

NONE

APPROVAL

I, THE UNDERSIGNED, AGREE THAT THE PRODUCT AS REPRESENTED SATISFIES DESIGN AND DIMENSION REQUIREMENTS. I ALSO ACKNOWLEDGE MY DUTY TO CONFIRM PRODUCT AND INSTALLATION COMPLIANCE WITH ALL APPLICABLE FEDERAL, STATE AND LOCAL REGULATIONS AND STANDARDS.
ALL SPECIAL UNITS ARE NON-RETURNABLE
[] As drawn [] As marked

Signed: _____ Date: _____

LEAD TIME WILL START UPON RECEIPT OF SIGNED APPROVAL DRAWING

FOR INTERNAL USE ONLY PROJECT SIGN OFF	
SALES	
ENG.	
FAB.	
POWER	

DISTRIBUTOR'S NAME:		P.O.#
VESTIL MANUFACTURING		X
DRAWN BY: B.NOTHNAGEL		DATE: 9/15/2015
REFERENCE: X		SCALE: 1:25
QUOTED LEAD TIME: X		QUOTE # X
		W.O.# X
		SALES: X
		FILE NAME: 44-007-484